

RGB/RGBW TOUCH WHEEL RF REMOTE CONTROLLER



1 Zone RGB/RGBW

Part Number:
ZL-REMOTE-RT4

4 Zone RGB/RGBW

Part Number:
ZL-REMOTE-RT9

- Apply to RGB or RGBW LED controller.
- Ultra sensitive color adjustment touch wheel.
- Independent dimming function of each R, G, B, W channel to achieve millions of colors.
- Each remote can match one or more receiver.
- AAx2 battery powered.
- Operate with LED indicator light.

CE RoHS  RED

TECHNICAL PARAMETERS:

Input and Output

- Output Signal: RF (2.4 GHz)
- Working Voltage: 3VDC (AAx2)
- Working Current: <5mA
- Standby Current: <10µA
- Standby Time: 1 year
- Remote Distance: 30m (Barrier-free space)

Safety and EMC

- EMC Standard (EMC): ETSI EN 301 489-1 V2.2.3
ETSI EN 301 489-17 V3.2.4
- Safety Standard: EN 61348-1:2015+A1:2021
EN 61348-2-13:2014+A1:2017
- Radio Equipment (RED): ETSI EN 300 328 V2.2.2
- Certification: CE, EMC, RED

Environment

- Operating Temp: -22°F to 131°F
- Package Size: L 5.52" x W 2.37" x H 1.03"
- Gross Weight: 0.088kg
- Warranty: 5 year

MECHANICAL STRUCTURES AND INSTALLATIONS

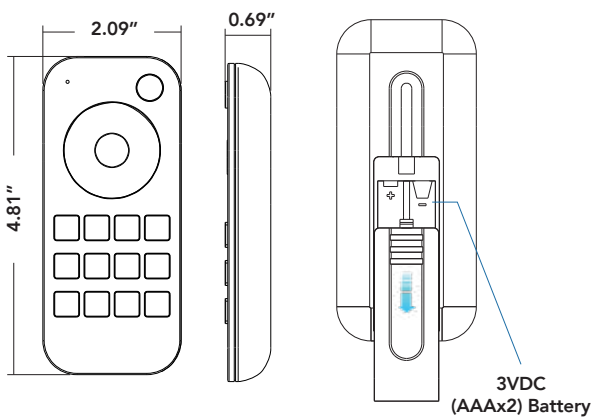

Back Holder

Two options are offered for selection, please fix the back holder on the wall with two screws, or adhere the back holder to the wall with paster.

1. Back holder without magnet

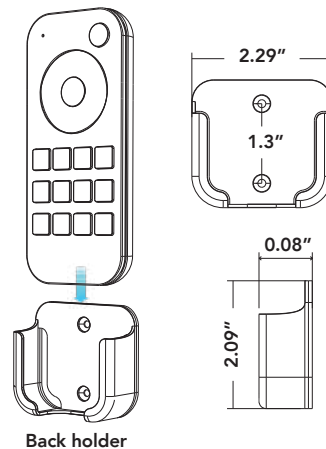

2. Back holder with magnet (The remote with built-in magnet)

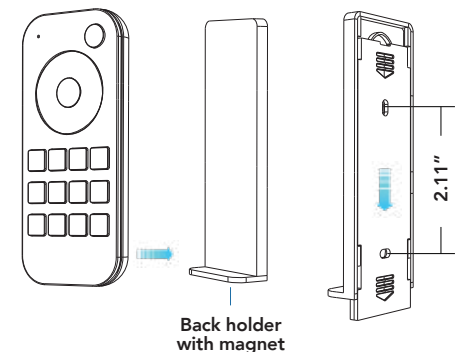

RGB/RGBW TOUCH WHEEL RF REMOTE CONTROLLER

OPERATION

- When turn on light, the indicator display blue. when turn off light, the indicator display red.
- When touch the color wheel, the indicator will display the same color.
- When press or touch operation is invalid (If the light is off), the indicator display red.
- To extend battery life, no touch or press key operation after a few seconds, the touch wheel will enter sleep state, you need press any key to make touch wheel quit sleep state.

MATCH REMOTE CONTROL (TWO MATCH WAYS)

End user can choose the suitable match/delete ways. Two options are offered for selection:

Use the controller's Match key

Match:

Short press match key, immediately press on/off key (single zone remote) or zone key (multiple zone remote) of the remote. The LED indicator fast flash a few times means match is successful.

Delete:

Press and hold match key for 5s to delete all match, The LED indicator fast flash a few times means all matched remotes were deleted.

Use Power Restart

Match:

Switch off the power, then switch on power, repeat again. Immediately short press on/off key (single zone remote) or zone key (multiple zone remote) 3 times on the remote. The light blinks 3 times means match is successful.

Delete:

Switch off the power, then switch on power, repeat again. Immediately short press on/off key (single zone remote) or zone key (multiple zone remote) 5 times on the remote. The light blinks 5 times means all matched remotes were deleted.

KEY FUNCTION

RT4 1 zone RGB/RGBW remote





 : Turn on/off light.

 : Touch to change static RGB color.

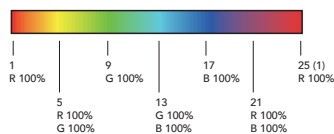
 : Short press get 24 kinds static RGB color, long press for continuous static color adjustment.



 : Short press run next dynamic mode, long press 2s run mode-cycle.

 : For dynamic RGB mode, adjust speed, short press 10 levels, long press 2s get the default speed.
For static RGB color, adjust saturation, namely change current static RGB color to mixed white slowly, short press 11 levels, long press 1-6s for continuous 256 levels adjustment.

 : Adjust brightness, short press 10 levels, long press 1-6s for continuous 256 levels adjustment.

 : Short press get redgreen or blue color directly. long press 1-s to adjust R/G/B brightness continuously, 6 to achieve millions of colors.

 : For RGB light, short press turn on/off white(RGB mix), long press 1-6s to adjust saturation continuously, namely change current static color to mixed white slowly. For RGBW light, short press turn on/off W channel, long press 1-6s to adjust W brightness continuously, namely change saturation by add white color slowly.

 : Short press recall the scene, long press 2s save current color into S1/2/3/4. the LED indicator display green when save OK.





RGB/RGBW TOUCH WHEEL RF REMOTE CONTROLLER

KEY FUNCTION

RT9 4 zone RGB/RGBW remote



 : Short press turn on/off all zone light.

 : Touch to change current zone static RGB color.

 : Short press select and turn on zone light, long press 2s turn off zone light.
Short press multiple zone key fastly, will select multiple zone synchronously.

 : Short press get red, green or blue color directly.
long press 1-6s adjust R/G/B brightness continuously to achieve millions of colors.

 : For RGB light, short press turn on/off white (RGB mix), long press 1-6s adjust saturation continuously, namely change current static RGB color to mixed white slowly.
For RGBW light, short press turn on/off W channel, long press 1-6s adjust W brightness continuously, namely change saturation by add white color slowly.

 : Adjust dynamic mode for current selected zone, Short press run next dynamic mode, long press 2s run mode-cycle.

 : For static color, adjust brightness, short press 10 levels, long press 1-6s for continuous 256 levels adjustment.
For dynamic mode, adjust speed, short press 10 levels, long press 2s get the default speed.

 : Short press recall the scene, long press 2s save current state into S1/S2. the LED indicator display green when save OK.
4 zone recall or save synchronously.

SAFETY INFORMATION

1. Read all instructions carefully before you begin this installation.
2. When installing battery, pay attention to the battery positive and negative polarity.
A long time without the remote control, remove the battery.
When remote distance becomes smaller and insensitive, replace the battery.
3. If no response from the receiver, please re-match the remote.
4. Gently handle remote, beware of falling.
5. For indoor and dry location use only.

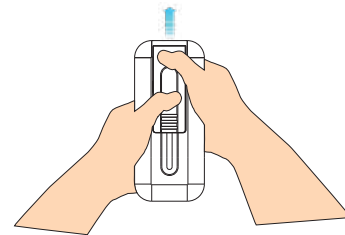

When replacing the batteries,
use both hands to remove the back cover of the remote control.

