

Distributor for:

**GRINSAFE®**

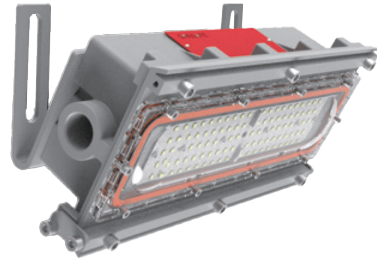

## FIREFLY™ GHW

### Hazardous Area Wall-pack Lighting

GHW Series hazardous location wall pack lighting is certified to UL standards for Class I Div. 2 and Class II Div. 1 environments, ensuring safe operation in areas with flammable gases and combustible dust. Designed for durability, it features robust housing, high efficacy output, and reliable performance in demanding industrial and outdoor applications.

### Compliance

#### NEC/CEC Standard

UL 844 Hazardous Locations  
Class I Division 2, Group A, B, C, D  
Class II Division 1, Group E, F, G  
Class II Division 2, Group F, G  
Class III  
Class I, Zone 2, Group IIC

#### CSA C22.2 No.137

CSA C22.2 No.250.0:21

UL 1598 Wet Locations

UL 1598A Marine Outside Type (Salt Water)

UL 8750 LED Safety

ABS

FCC

IP66/67 | IK10 | 5G | NEMA 4X

### Dimensions

unit: mm(in)

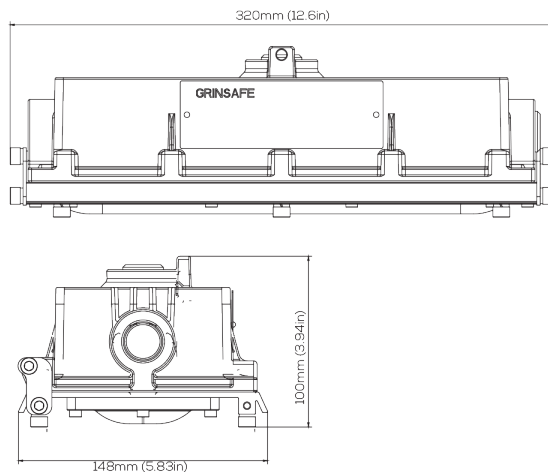

### Warranty

5-year limited system warranty

Lumen Maintenance: L70 > 150,000 hours @ 25°C

### Technical Data

#### Electrical

Rated Power	20W / 30W
Input Voltage	100-277V/AC
Input Frequency	50/60Hz
Power Factor	> 0.95
Driver Efficiency	≥ 90%
DC output Ripple & Noise	< 200mVP-P

#### Optical

Lumen Output	3,300lm / 4,950lm
Luminous Efficacy (Lumens per Watt)	165 lm/W
Beam Angle	110°
Correlated Color Temperature (CCT)	Amber 2700K 3000K 4000K 5000K
CRI	Ra>70

#### Environmental

Ambient Operating Temperature	-40°C~+65°C
Ambient Operating Humidity	10%~90% RH
Atmospheric pressure	86~106KPa

#### Technical

Lens Material	Polycarbonate
Mounting Options	Wall mount / Ceiling mount
Cable Entry	3/4" NPT
Net Weight	2.7kg (5.95lbs)

### Beam Distribution

110°

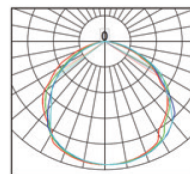

### Downloadable IES Files



## Ordering Information and Mounting Accessories

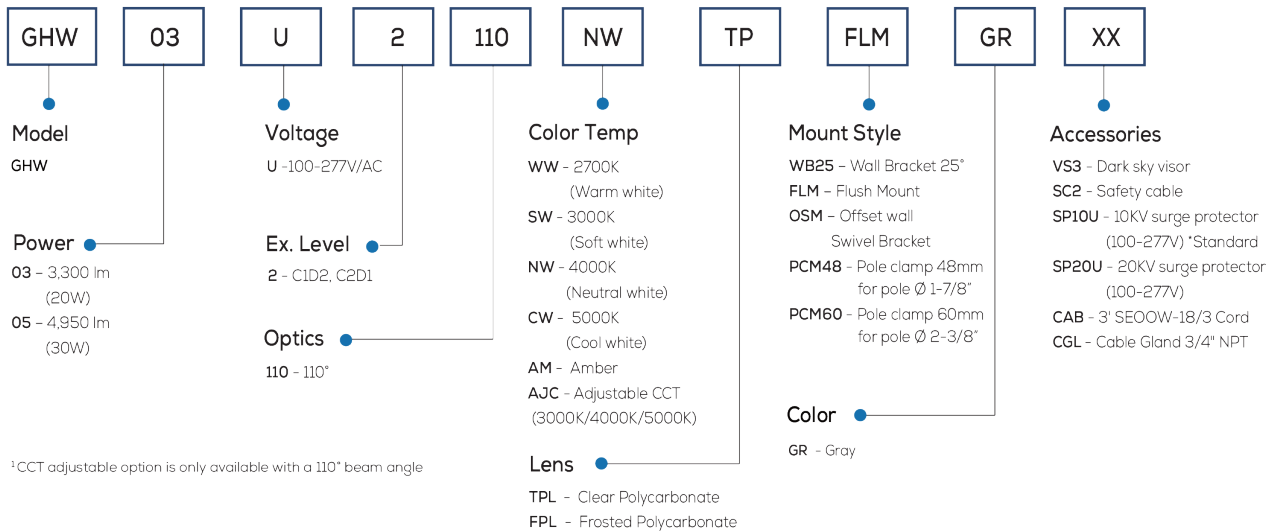

## Mounting Options



**WB25**  
Wall bracket 25°

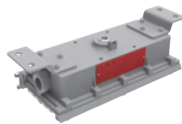

**FLM**  
Flush mount

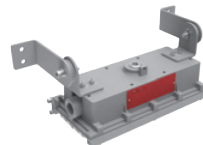

**OSM**  
Offset ceiling / wall Swivel Bracket

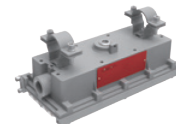

**PCM48**  
Pole clamp 48mm for pole Ø 1-7/8"

**PCM60**  
Pole clamp 60mm for pole Ø 2-3/8"

## Accessories



**WB25**  
Wall Bracket Mount Kit 1 pair



**FLM**  
Flush Mount Kit 1 pair



**OSM**  
Offset ceiling / wall Swivel Bracket



**VS3**  
Stainless steel dark sky visor



**SC2**  
Stainless steel safety cable Ø6 (3mm)



**CAB**  
3' SE00W-18/3 Cord (Factory installed)



**PCM48**  
Pole clamp 48mm 1 pair for pole Ø 1-7/8"



**CGL**  
Cable Gland 3/4" NPT Suitable for C1D2



**SP10U**  
10KV Surge Protector (100-277V) \*Standard



**SP20U**  
20KV Surge Protector (100-277V)

**PCM60**  
Pole clamp 60mm 1 pair for pole Ø 2-3/8"



# Firefly™ GHW Hazardous Area Wall Pack Lighting

## Important Information

This manual contains safety information, please read carefully and follow the instruction strictly.

## WARNING: INSTALLATION & SECONDARY RETENTION

Improper installation and handling, including secondary safety retention/securing/netting, may cause severe injury or death. We recommend that all installations should use secondary retention and/or safety netting (appropriate to the installation environment) where applicable. It is the exclusive responsibility of the contractor, installer and/or end customer to: (a) determine the suitability of the product for its intended application; and, (b) ensure that the product is installed safely (with secondary retention and/or safety netting where appropriate) and in compliance with all applicable laws and regulations. To the extent permissible under the relevant law, we disclaims all responsibility for personal injury and/or other damage resulting from any dislodgement or other dislocation of this product.

## WARNING

To avoid the risks of fire, explosion, or electric shock, this product should be installed, inspected, and maintained by a qualified electrician in accordance with all applicable electrical rules and regulations.

### Safety Instructions:

- Be certain, the electrical power is OFF before and during installation and maintenance.
- Make sure the supply voltage is the same as the rated luminaire voltage.
- The technical data indicated on the LED luminaires are to be observed.
- Any change on the design and modifications to the LED luminaire are not permitted.
- Observe the national/regional electrical safety rules and regulations during installation.
- LED beads are NOT replaceable. Replacement of whole set of light fixture is strongly recommended.
- All wiring connections should be capped with UL approved wire connectors.
- Luminaire MUST be well grounded.
- Any combustible materials MUST be kept away from the luminaire.
- Min 90°C supply conductors.
- Do not open the cover after installing the luminaire.

### Maintenance:

1. To avoid personal injury, before maintaining, disconnect the light first, and then wait for the luminaire temperature dropping into the safe range.
2. All parts must be checked by mechanical means to ensure they are properly assembled.
3. The external glass should be cleaned regularly to ensure continued luminaire performance. Wipe the glass with a clean, wet, non-abrasive, and lint-free cloth. If this is not sufficient, use mild soap or liquid cleaner. Do NOT use an abrasive, strong alkaline or acid detergent which might damage the luminaire.
4. Check the cooling fins of the luminaire and remove the dust or other sorts of things which accumulated on the luminaire.
5. Visual, electrical and mechanical inspections on the luminaire should be on a regular basis. We highly suggest that this routine inspection should be done at least once a year. The environment condition, where the luminaire installed, determines the frequency of inspection.
6. All electric connections MUST be checked and ensured that they are clean and firm.



**Electrical Connections:**

**WARNING:**

Cut off the electric power supply from the circuit breaker or the fuse before wiring luminaire to the circuit.

Do not connect the dimming wires. The connections are marked on the wire connector or on a label and are presented figure below.

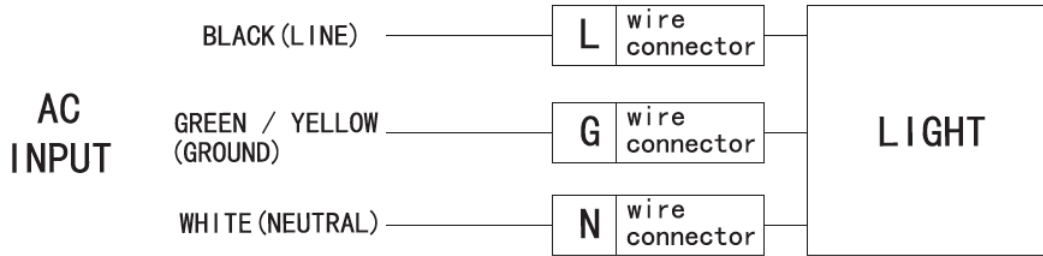

**Installation & Operations:**

1. Loosen the M6 Socket head cap screws on the Tank Cover.
2. Attach the Tank to the 3/4" NPT conduit.
3. Thread the wire through conduit, and connect to wire connector.
4. Re-attach the Tank cover and tight it by M6 Socket head cap screws with torque value 10 N-m.
5. Check the tightness of conduit and Tank.

**Technical Diagrams:**

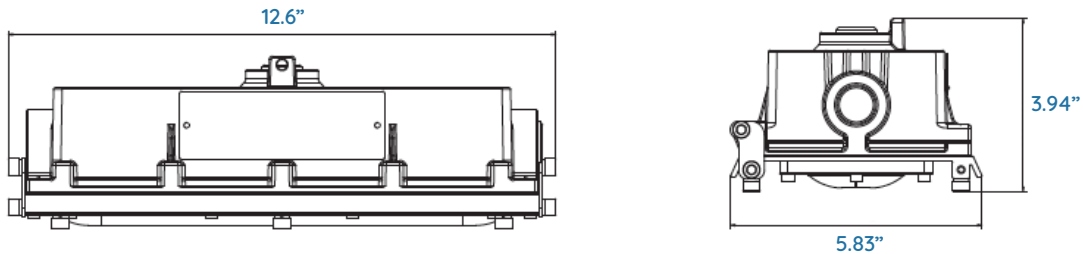

**Installation:**

Flush mount by Ceiling-Bracket

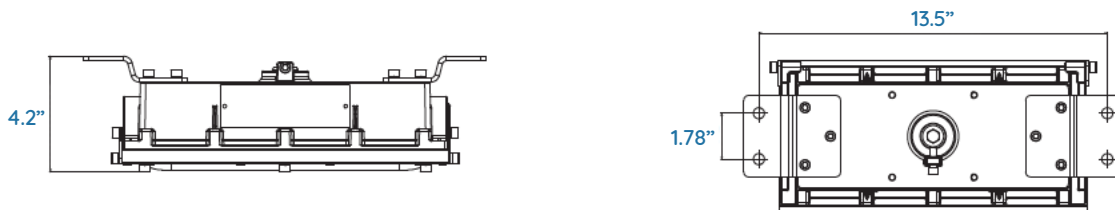

Ceiling / Wall Swivel mount

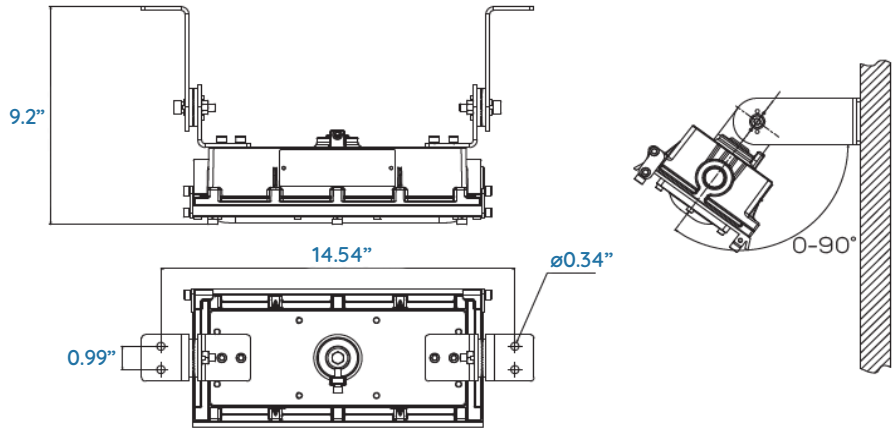

The statement for Class II only:  
"Mounting Orientation – Lens Facing  
Down 0°~90° From Vertical Only".

Pole Mount

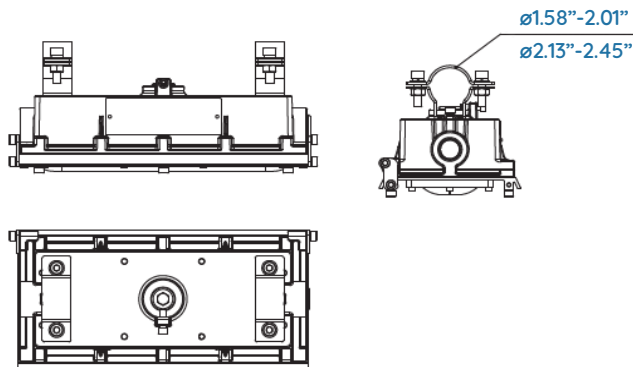

Wall Mount

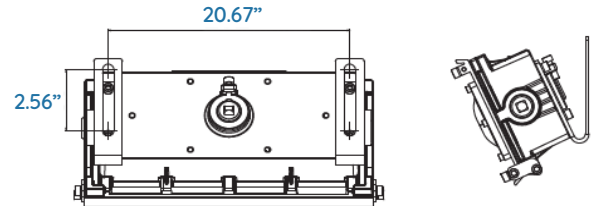

**Flush mount by Ceiling-Bracket:**

1. Fix the bracket on the lamp with M6 screws, Torque: 7 N-m.
2. Mount the luminaire.
3. Connect wires to the wire connector.

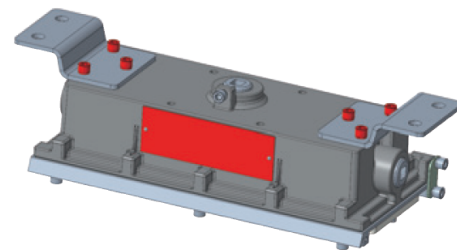

**Ceiling / Wall Swivel mount:**

Once mounted, the angle of the luminaire can be adjusted by loosening the M8 socket head cap screw on each side of the bracket. When loosening, do not back bolt out more than 5 full rotations. When the desired angle has been achieved, the bolts can be tightened to lock in the angle. Torque: 10 N-m.

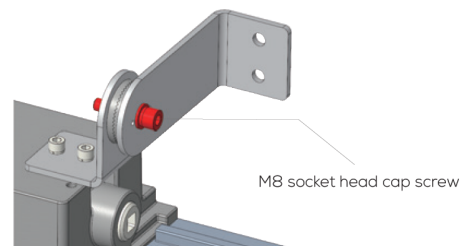

**Pole Mount:**

Install the lower collar on the lamp body and lock it with M6 hexagon socket screws Torque: 7 N-m

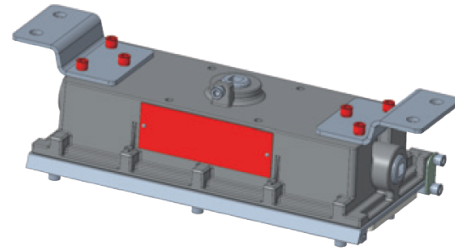

**Ceiling / Wall Swivel mount:**

Once mounted, the angle of the luminaire can be adjusted by loosening the M8 socket head cap screw on each side of the bracket. When loosening, do not back bolt out more than 5 full rotations. When the desired angle has been achieved, the bolts can be tightened to lock in the angle. Torque: 10 N-m.

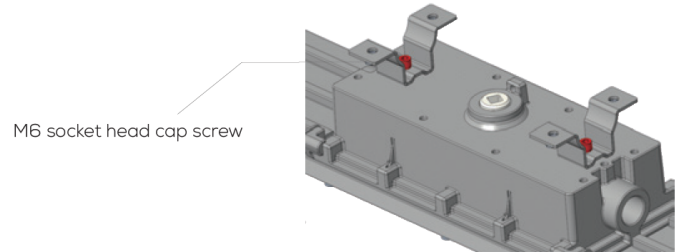

After it is installed on the pipe fitting, the upper collar is fixed and locked with M6 inner hexagon screws; Torque: 7 N-m

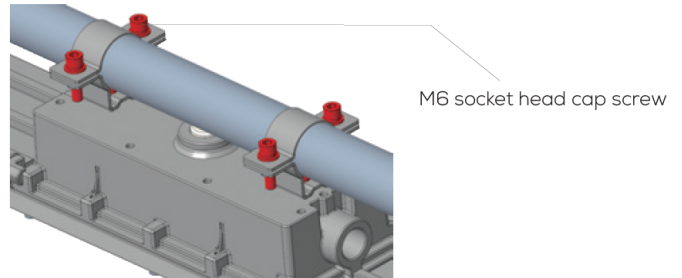

**Wall Mount:**

1. Fix the bracket on the lamp with M6 screws, Torque: 7 N-m.
2. Mount the luminaire.
3. Connect wires to the wire connector.

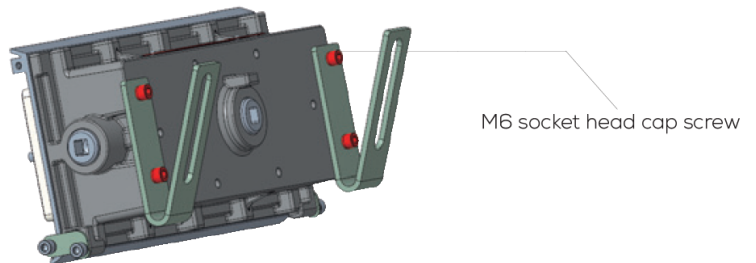

**Models:**

Models GH; followed by W: followed by -05, -03

Models	Power	Rated Voltage	Ambient Temp
GHW-03-U	20W	U:100-277V	-40°C (-40°F) ~ +65 °C (149 °F)
GHW-05-U	30W	U:100-277V	

