

UFO LED HIGH BAY - WHITE



APPLICATIONS

- Warehouses
- Manufacturing factories
- Parking garages
- Gymnasiums

PART NUMBERS

ZL-WS-UFO-100W-50K-WH
ZL-WS-UFO-150W-50K-WH
ZL-WS-UFO-200W-50K-WH
ZL-WS-UFO-240W-50K-WH

PRODUCT SPECIFICATIONS

WATTAGES	100W, 150W, 200W, 240W
COLOR TEMPS	50K
EFFICACY	160 lm/W
LUMENS	100W- 16,000; 150W- 24,000; 200W- 32,000; 240W- 38,400
INPUT VOLTAGE	120/277V
CRI	>72Ra
BEAM ANGLE	75°
DIMMING	0-10V optional
OPERATING TEMP	-22° to 103°F
LED LIFESPAN (L70)	50,000 hours
DIMENSIONS (WxH)	100W- 7.1" x 7.6" 150W- 13.4" x 7.64" 200W+240W- 15.8" x 7.9"
LISTED	UL
WARRANTY	5 year

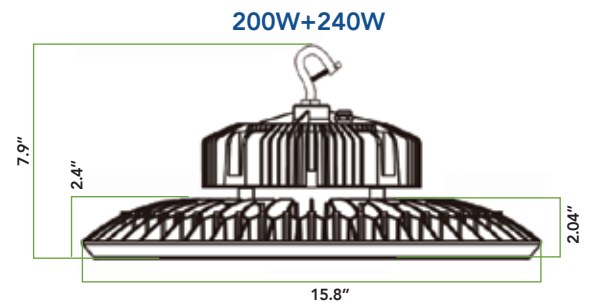
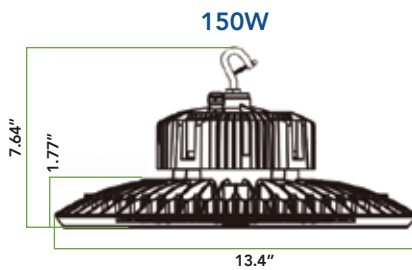
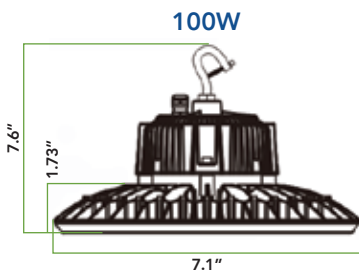

PHOTOMETRICS

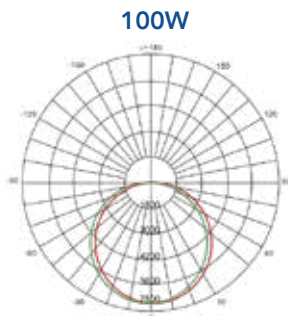

UNIT:CD
Test Number:LS-5EHB100W-50K - C0/180,113.7
Lumens:16000LM - C30/210,100.1
Test Number:100W - C60/240,108.6
Test Number:5000K - C90/270,130.9

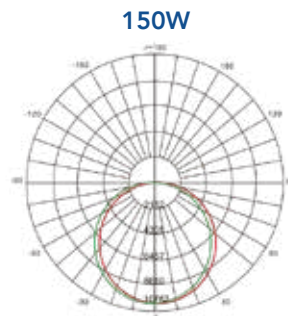

UNIT:CD
Test Number:LS-5EHB150W-50K - C0/180,113.7
Lumens:24000LM - C30/210,100.1
Test Number:150W - C60/240,108.6
Test Number:5000K - C90/270,130.9

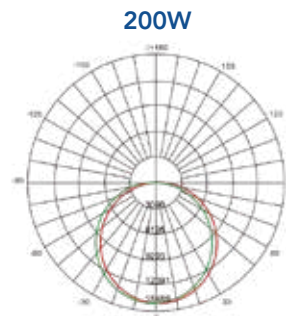

UNIT:CD
Test Number:LS-5EHB200W-50K - C0/180,113.7
Lumens:32000LM - C30/210,100.1
Test Number:200W - C60/240,108.6
Test Number:5000K - C90/270,130.9

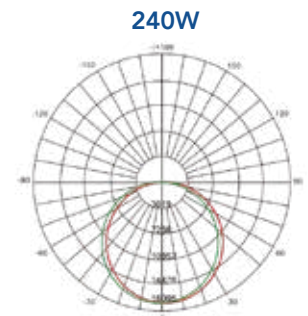

UNIT:CD
Test Number:LS-5EHB240W-50K - C0/180,113.7
Lumens:38400LM - C30/210,100.1
Test Number:240W - C60/240,108.6
Test Number:5000K - C90/270,130.9